

PIXUS iP90

PIXMA iP90

PARTS CATALOG

REVISION 0

9644A001AA	PIXMA iP90/ 120V(US)
9644A002AA	PIXMA iP90/ 120V(CA)
9644A003AA	PIXMA iP90/ 120V(LAM LVT)
9644A005AA	PIXMA iP90/ 220V-240V(EMB)
9644A008AA	PIXMA iP90/ 220V-240V(ASA HVT)
9644A009AA	PIXMA iP90/ 220V-240V(AU)
9644A010AA	PIXMA iP90/ 220V-240V(KR)
9644A011AA	PIXMA iP90/ 220V-240V(GB)
9644A012AA	PIXUS iP90/ 100V(JP)
9644A013AA	PIXMA iP90/ 120V(TW)
9644A014AA	PIXMA iP90/ 220V-240V(HK)
9644A015AA	PIXMA iP90/ 220V-240V(CN)
9644A017AA	PIXMA iP90/ 220V-240V(EUM)



JAN. 2005

QY8-31C9-000

COPYRIGHT © 2005 CANON INC. CANON PIXUS iP90/PIXMA iP90 0105 N 0.00-0

Application

This manual has been issued by Canon Inc. for qualified person to learn technical theory, installation, maintenance, and repair of products. This manual covers all localities where the products are sold. For this reason, there may be information in this manual that does not apply to your locality.

Corrections

This manual could include technical inaccuracies or typographical errors due to improvements or changes in the products. When changes occur in applicable products or in the content of this manual, Canon will release technical information as the need arises. In the event of major changes in the contents of this manual over a long or short period. Canon will issue a new editions of this manual. The following paragraph does not apply to any countries where such provisions are inconsistent with local law.

Trademarks

The product names and company names described in this manual are the registered trademarks of the individual companies.

Copyright

This manual is copyrighted with all rights reserved. Under the copyright laws, this manual may not be copied, reproduced or translated into another language, in whole or in part, without the written consent of Canon Inc.

Copyright © 2005 by Canon Inc.

CANON INC.

Inkjet Device Quality Assurance Div. 1

16-1, Shimonoge 3-chome, Takatsu-ku, Kawasaki-shi, Kanagawa 213-8512, Japan

This manual was created under Microsoft® Windows® 2000.

Parts layout pictures were edited using Adobe® Photoshop® 7.0. KEY No. were created using Adobe® Illustrator® 10.

HTML files were created using Microsoft® FrontPage® 2000.

ABOUT THIS MANUAL

A. ILLUSTRATION INDEX

For illustration index, the parts layout illustrations in this parts catalog are listed in abbreviated form in order of illustration number to identify the pages they appear on. To find an illustration of a part, see the ILLUSTRATION INDEX.

B. PARTS LAYOUT & PARTS LIST

Parts layout illustration

a) Parts search

Find a part from the parts layout illustration and find its key number from the parts list to identify the part number and name. For screws, nuts, washers, lock washers, pins, spacers, see SCREWS & WASHERS LIST.

Note: If parts have the same or similar shape but different specifications, their key number is assigned to several part numbers and names in the parts list.

b) Parts replacement procedure

To replace parts, the parts layout illustrations have figure numbers according to the disassembly procedure of the product. The parts that require careful work are shown the illustration.

Parts list

a) FIGURE & KEY No.

The FIGURE & KEY No. column corresponds to the key numbers assigned to the parts in the parts layout illustration.

b) PART NUMBER

The PART NUMBER column gives the part numbers corresponding to the key numbers. To order a part, indicate the part number clearly.

Note: Parts marked NPN are not service parts.

c) RANK

The service parts with N in the RANK column are order parts.

d) QTY

The QTY column gives the number of parts in the corresponding components layout illustration.

e) DESCRIPTION

The DESCRIPTION column gives the part names in English.

To order a part, indicate the part name, too.

C. OPTIONS & CONSUMABLES

These are illustrations and a list of units that can be used as optional consumable equipments.

D. SCREWS & WASHERS LIST

This is a list of screws, nuts, washers, lock washers, pins, and spacers.

The QTY column does not give the number of parts used.

E. TOOL LIST

This is a list of tools used for servicing products.

F. NUMERICAL INDEX

All the parts listed in this parts catalog are arranged in order of part number. You can identify part locations and names from the NUMERICAL INDEX.

Contents

- A. ILLUSTRATION INDEX ▶**
- B. PARTS LAYOUT & PARTS LIST ▶**
- C. OPTION & CONSUMABLES ▶**
- D. SCREW & WASHER LIST ▶**
- E. TOOL ▶**
- F. NUMERICAL INDEX ▶**

A. ILLUSTRATION INDEX

FIGURE 1 PRINTER & PRINT HEAD



FIGURE 2 OUTPUT COVER UNIT & I/F COVER

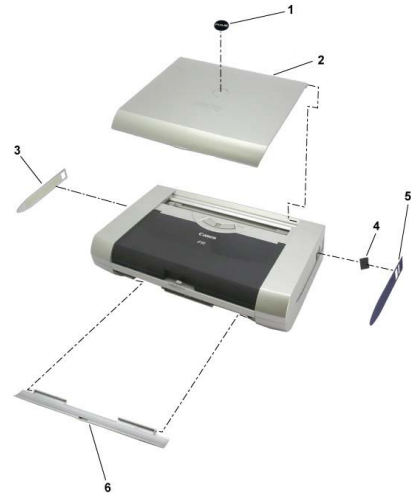

FIGURE 3 MAIN CASE UNIT

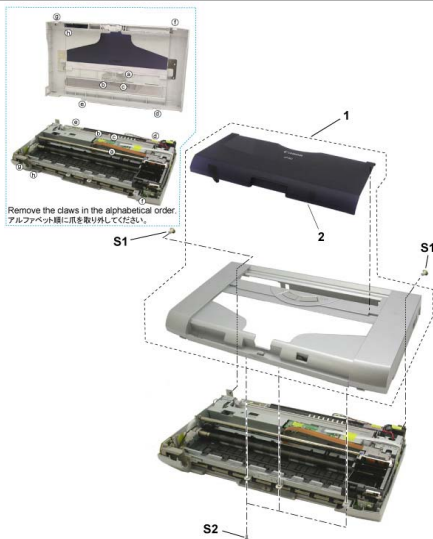

FIGURE 4 PRESSING PLATE UNIT

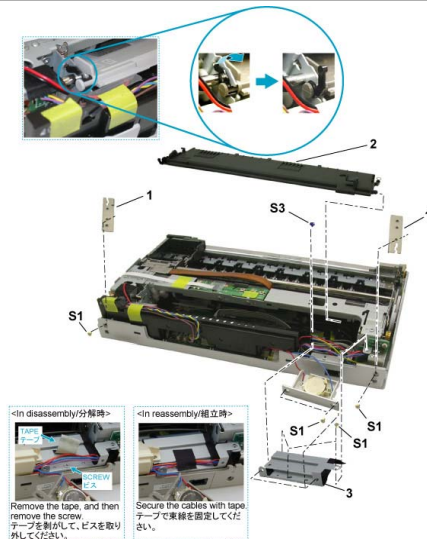

FIGURE 5 FERRITE CORE (FFC & HARNESS)

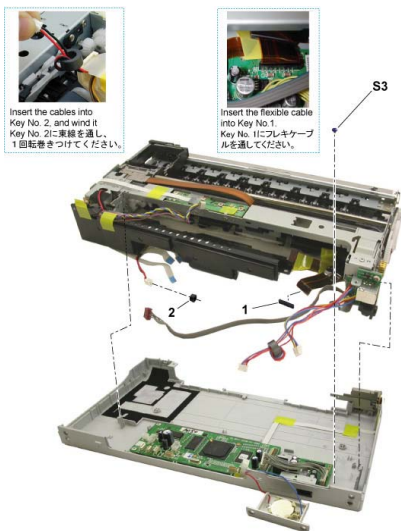

FIGURE 6 PRINT UNIT & DRAIN PACK ASS'Y

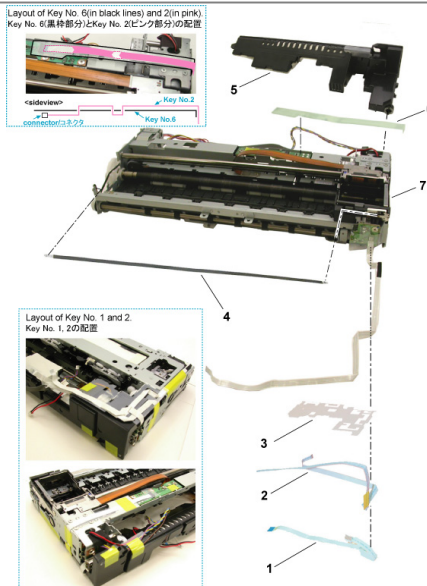

FIGURE 7 BOARD PARTS

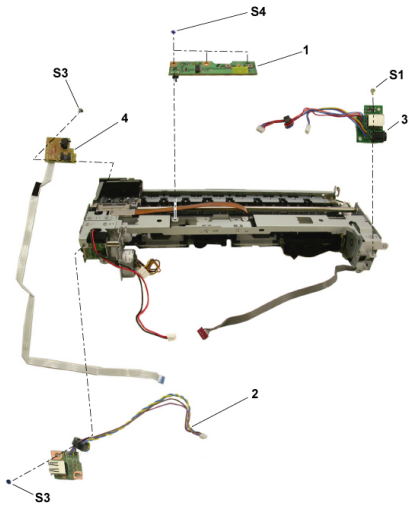

FIGURE 8 INK ABSORBERS

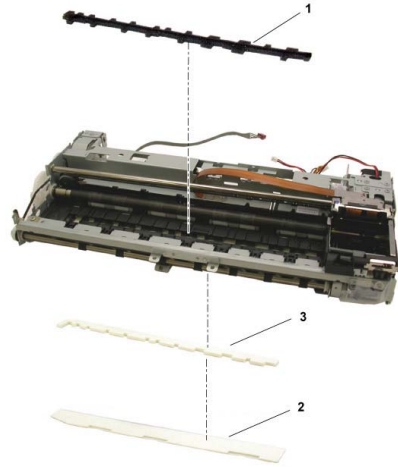

FIGURE 9 CARRIAGE UNIT & PURGE UNIT

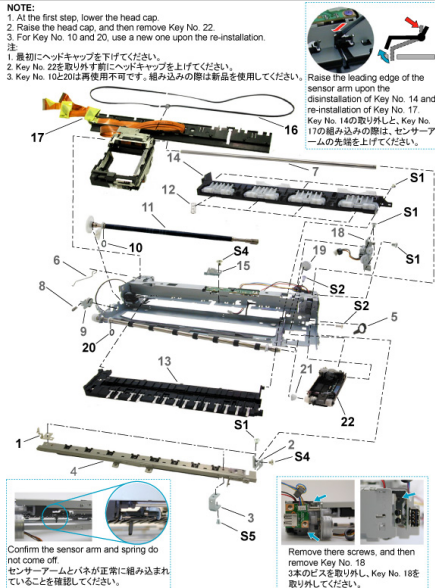

FIGURE 10 MAIN BOARD PARTS & COIN BATTERY UNIT

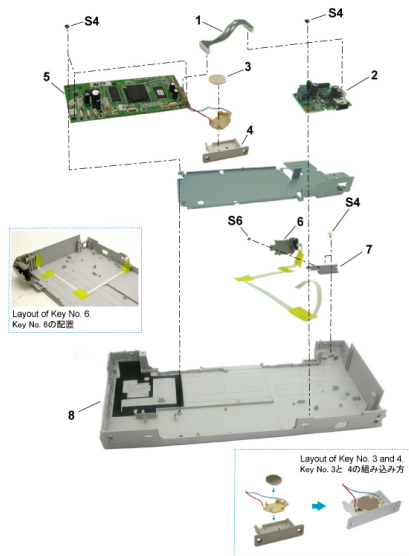
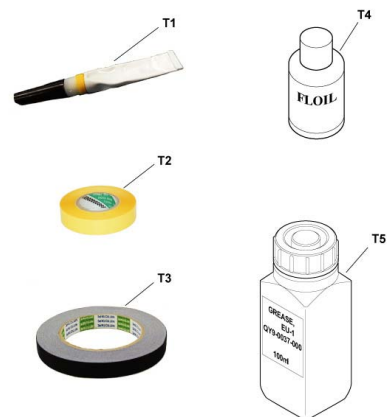

FIGURE 11 OPTION & CONSUMABLES



FIGURE 12 TOOL



This page intentionally left blank

FIGURE 1 PRINTER & PRINT HEAD



FIGURE & KEY No.		PART NUMBER	RANK	QTY	DESCRIPTION	REMARKS
1 -	1	QY6-0052-000		1	PRINT HEAD	

FIGURE 2 OUTPUT COVER & I/F COVER

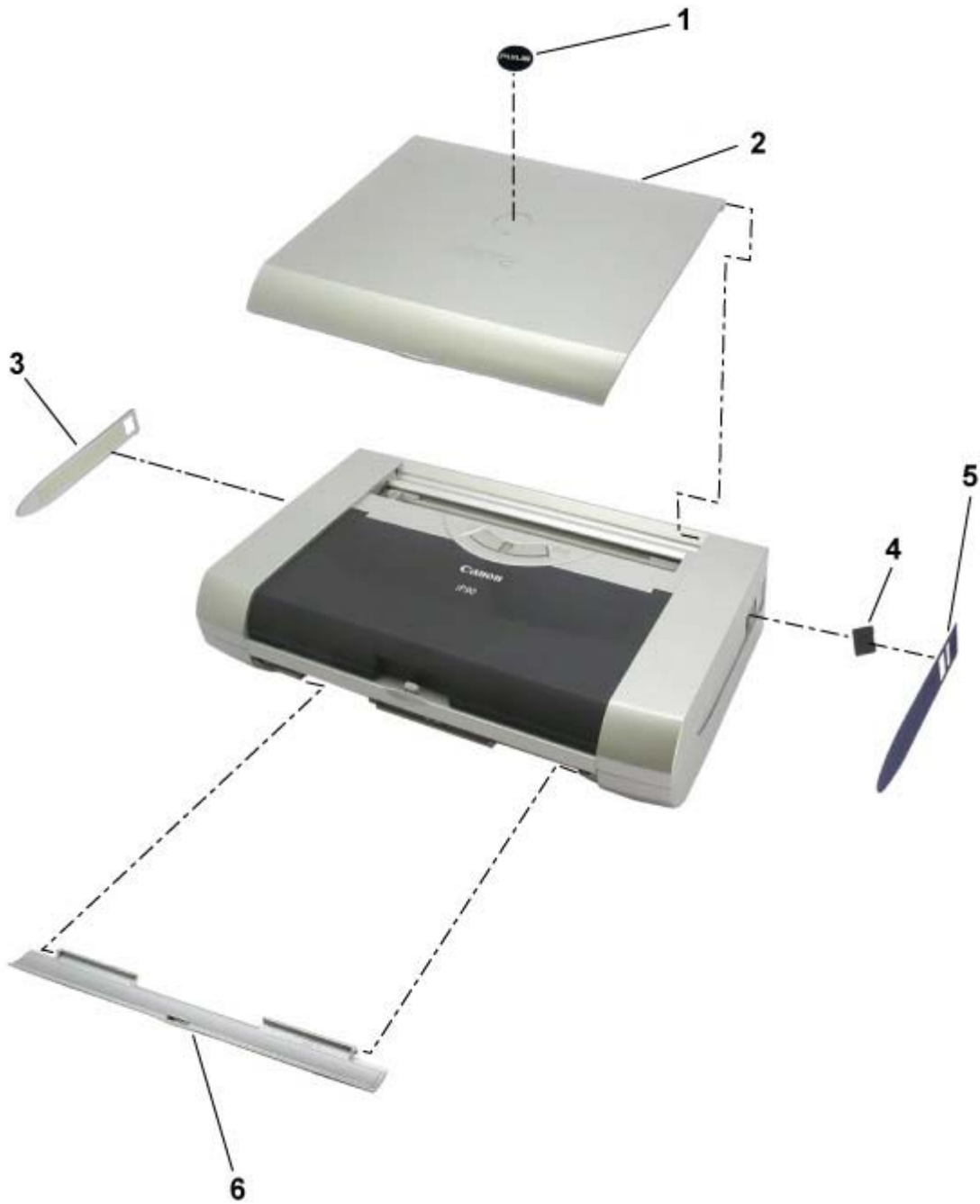

FIGURE & KEY No.		PART NUMBER	RANK	QTY	DESCRIPTION	REMARKS
2 -	1	QC1-5805-000		1	EMBLEM, PIXMA	
		QC1-5834-000		1	EMBLEM, PIXUS	
	2	QL2-0869-000		1	TRAY, FEED PIXUS	JP
		QL2-0873-000		1	TRAY, FEED PIXMA	OVERSEAS
	3	QC1-5812-000		1	COVER, SIDE L	
	4	QC1-5801-000		1	WINDOW, SIDE	
	5	QC1-5802-000		1	COVER, SIDE R	
	6	QL2-0870-000		1	OUTPUT SLOT COVER UNIT	

FIGURE 3 MAIN CASE UNIT

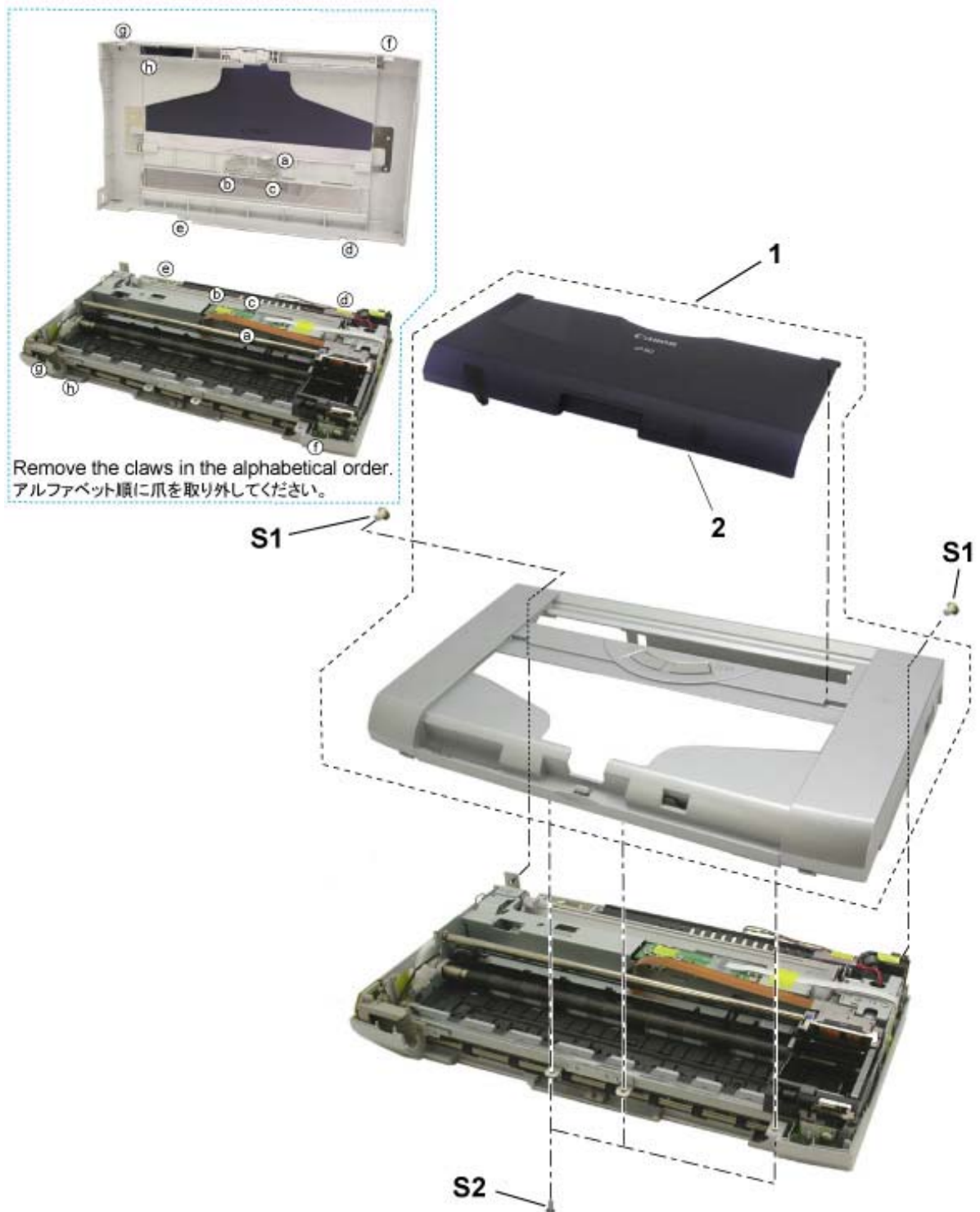

FIGURE & KEY No.		PART NUMBER	RANK	QTY	DESCRIPTION	REMARKS
3 -	1	QM2-2015-000		1	MAIN CASE UNIT	
	2	QC1-5793-000		1	COVER, PRINT HEAD	

FIGURE 4 PRESSING PLATE UNIT

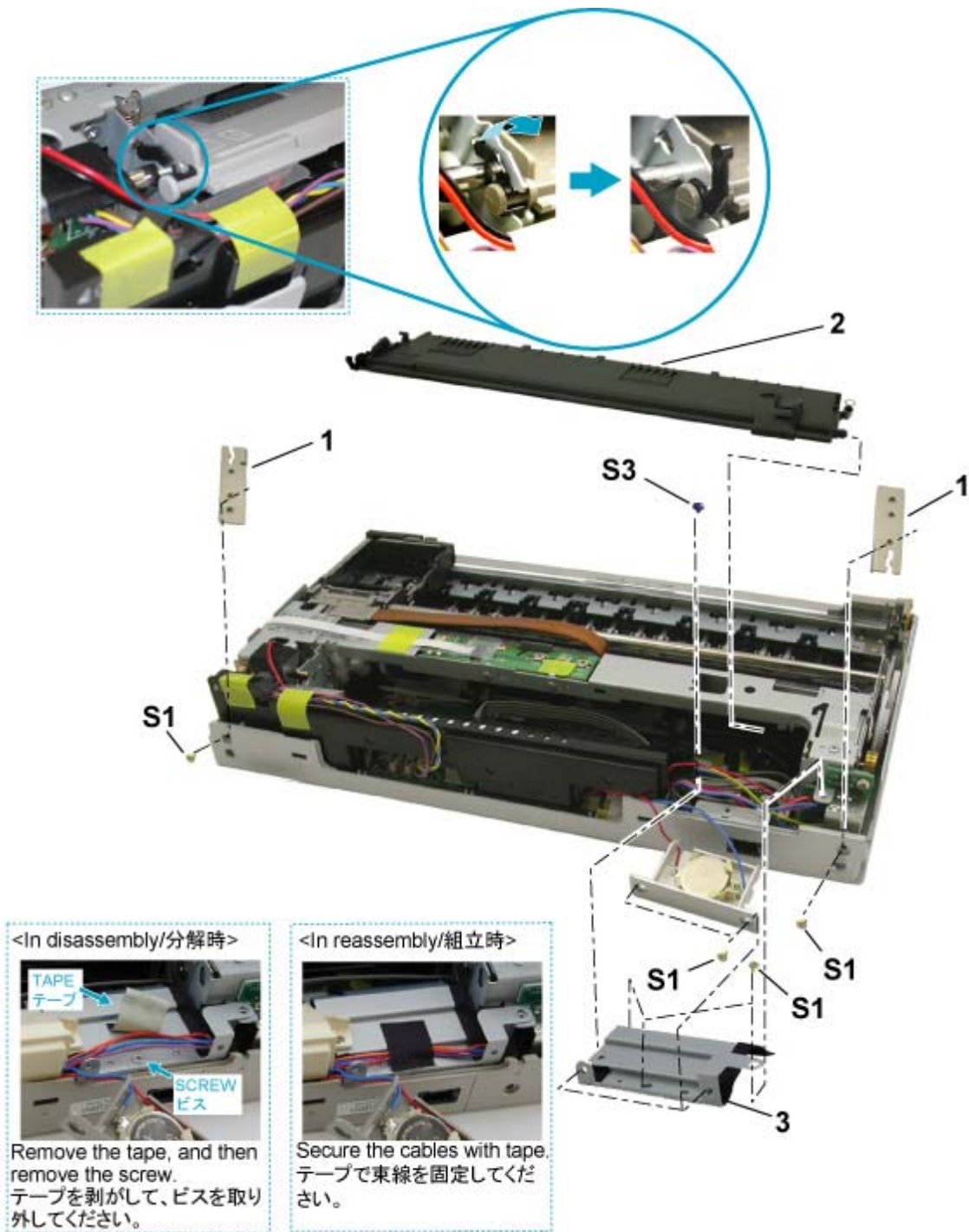

FIGURE & KEY No.		PART NUMBER	RANK	QTY	DESCRIPTION	REMARKS
4 -	1	NPN		2	PLATE, CRAMP	
	2	QM2-2017-000		1	PRESSING PLATE UNIT	
	3	NPN		1	PLATE, SHIELD	

FIGURE 5 FERRITE CORE (FFC & HARNESS)



Insert the cables into Key No. 2, and wind it Key No. 2に束線を通し、1回転巻きつけてください。



Insert the flexible cable into Key No.1. Key No. 1にフレキケーブルを通してください。

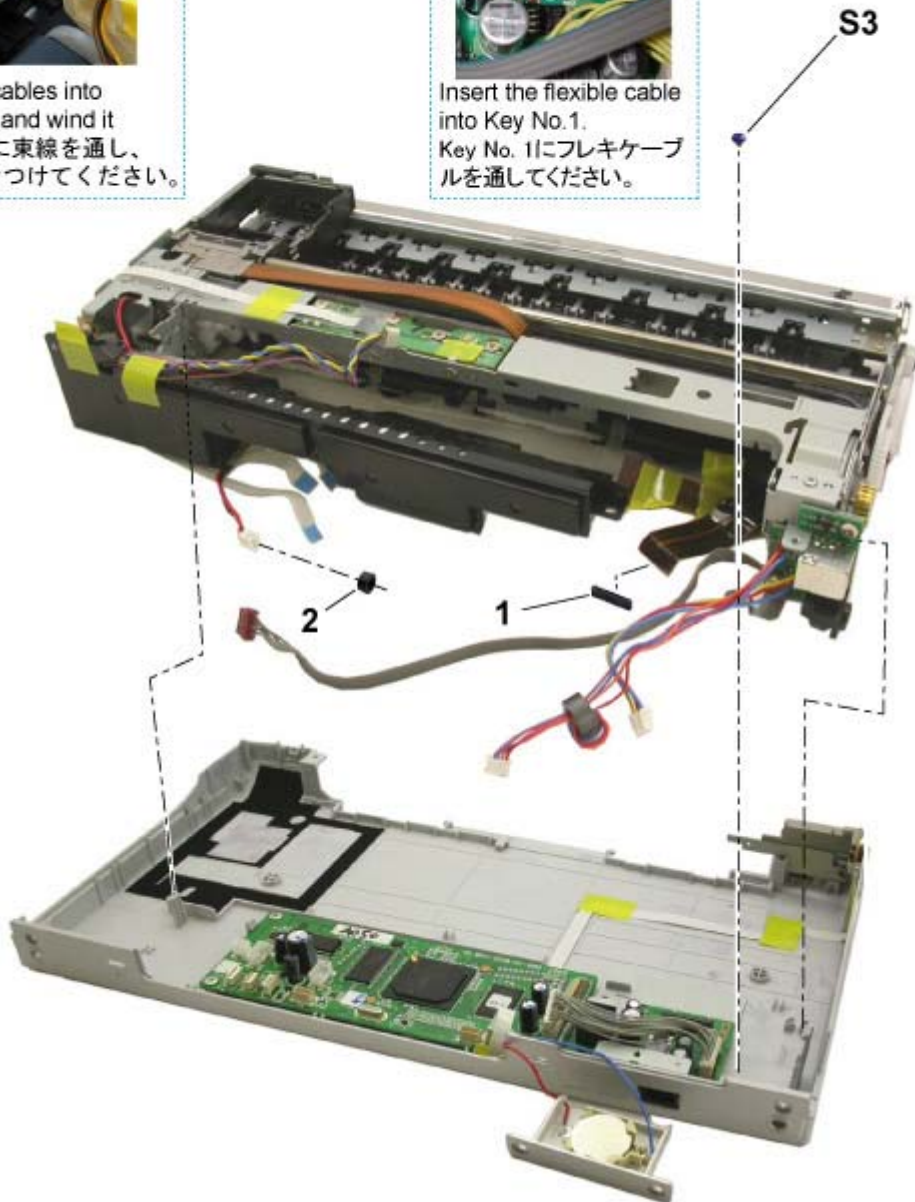

FIGURE & KEY No.		PART NUMBER	RANK	QTY	DESCRIPTION	REMARKS
5 -	1	WE8-6242-000		1	CORE, FERRITE	
	2	WE8-6045-000		1	CORE, FERRITE RING	

FIGURE 6 PRINT UNIT & DRAIN PACK ASS'Y

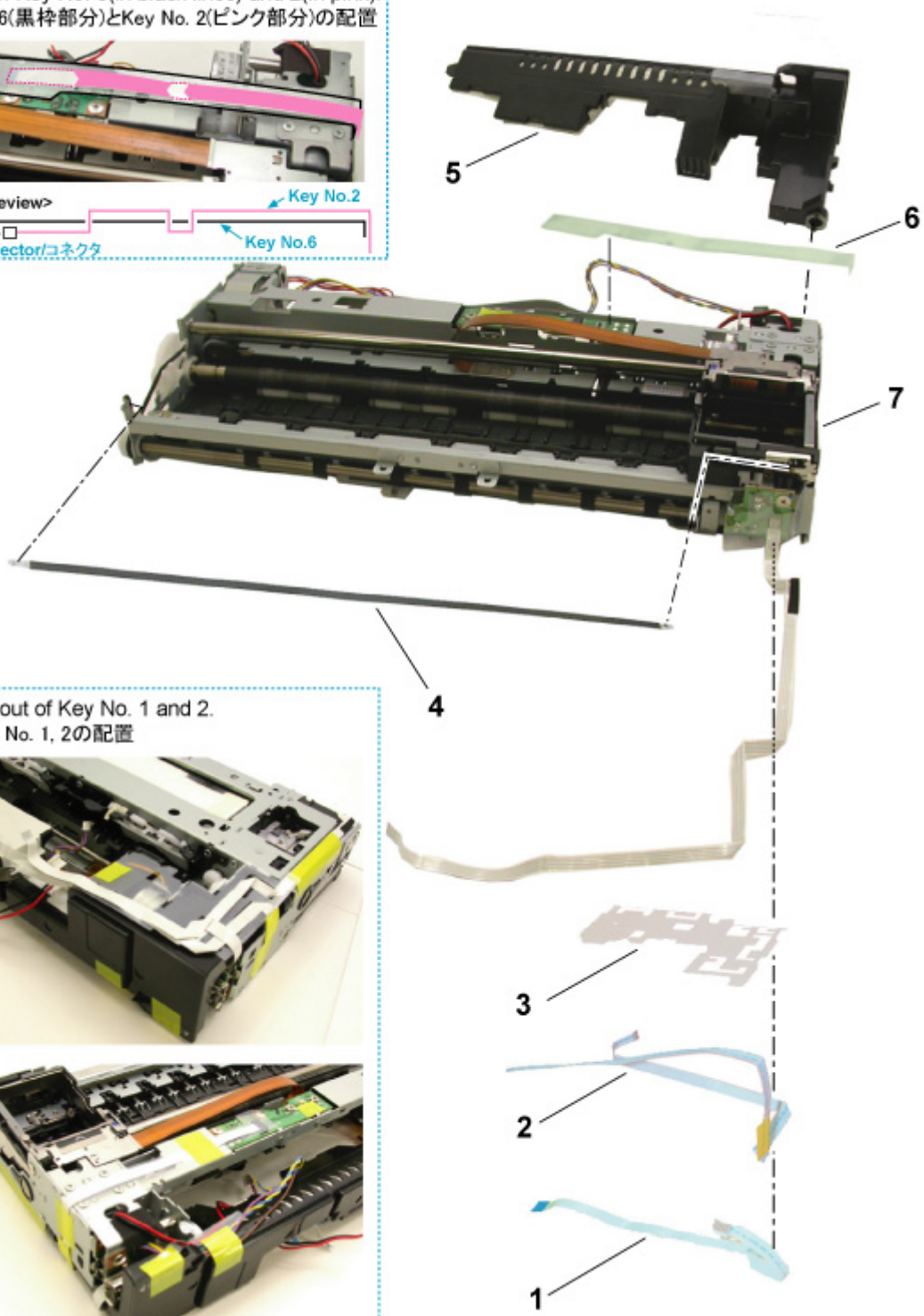
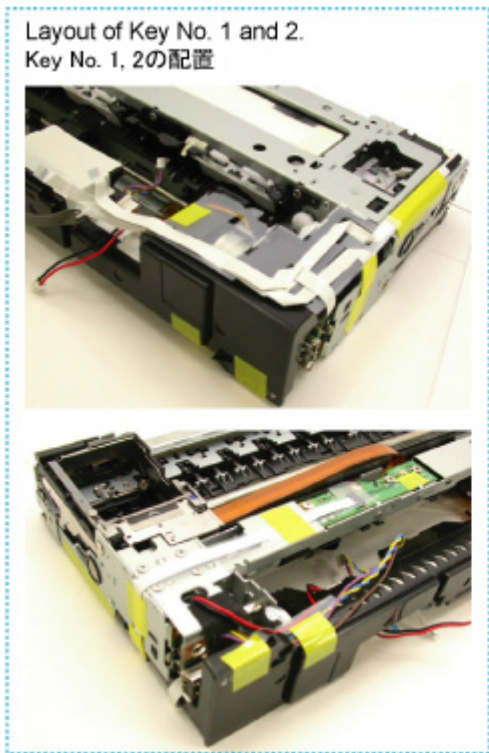

FIGURE & KEY No.		PART NUMBER	RANK	QTY	DESCRIPTION	REMARKS
6 -	1	QK1-1237-000		1	CABLE, IRDA FLEXIBLE	
	2	QK1-1236-000		1	CABLE, PANEL FLEXIBLE	
	3	QC1-1310-000		1	HOLDER, FLEXIBLE CABLE	
	4	QC1-3998-000		1	FILM, TIMING SLIT STRIP	
	5	QL2-0194-000		1	DRAIN PACK ASS'Y	
	6	QC1-5789-000		1	SHEET, EDGE COVER	
	7	QM2-2020-000		1	PRINT UNIT	

FIGURE 7 BOARD PARTS

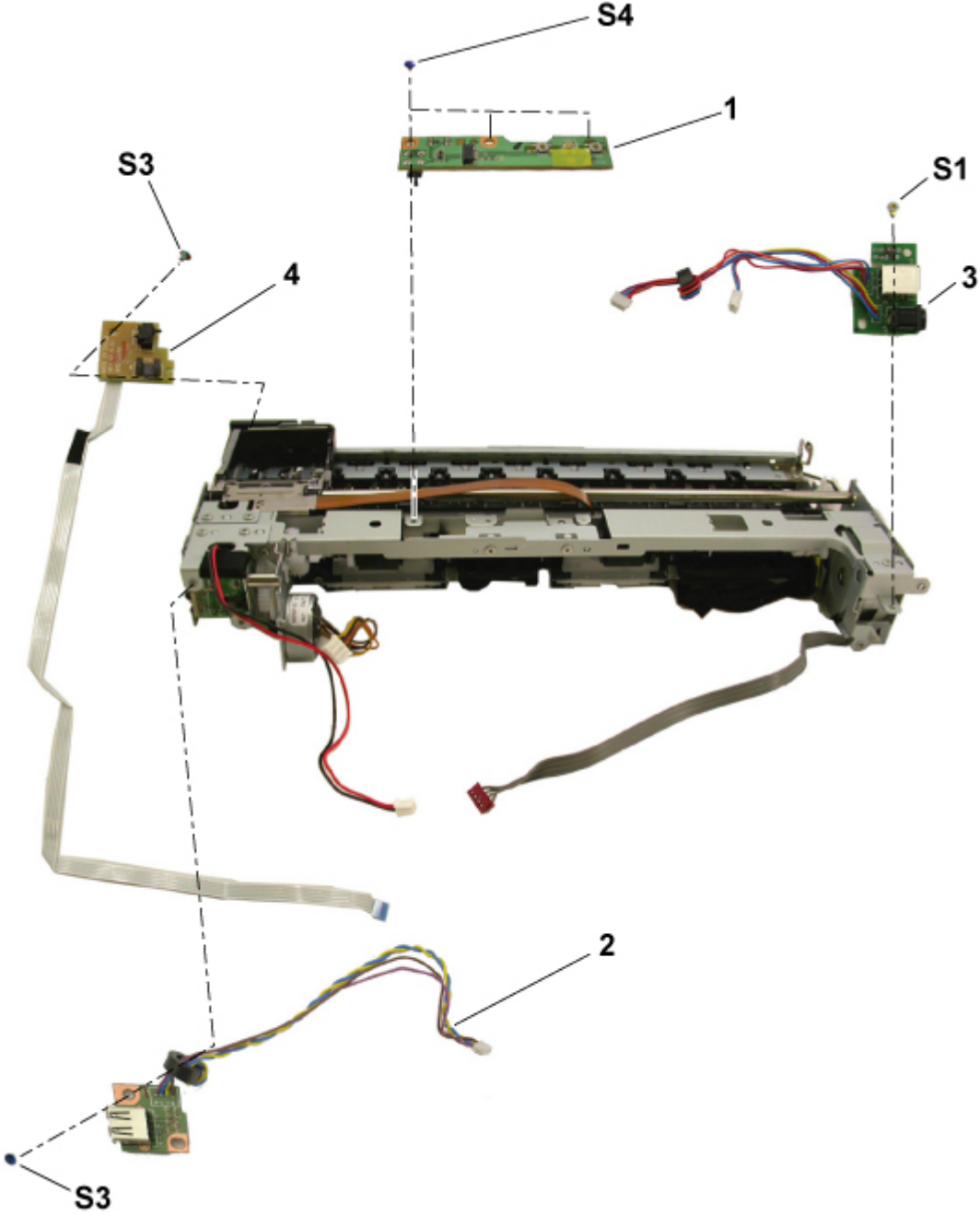

FIGURE & KEY No.		PART NUMBER	RANK	QTY	DESCRIPTION	REMARKS
7 -	1	QM2-2069-000		1	PANEL BOARD ASS'Y	
	2	QM2-2074-000		1	DCD BOARD ASS'Y	
	3	QM2-2022-000		1	USB BOARD ASS'Y	
	4	QM2-2070-000		1	DOOR SENSOR BOARD ASS'Y	

FIGURE 8 INK ABSORBERS

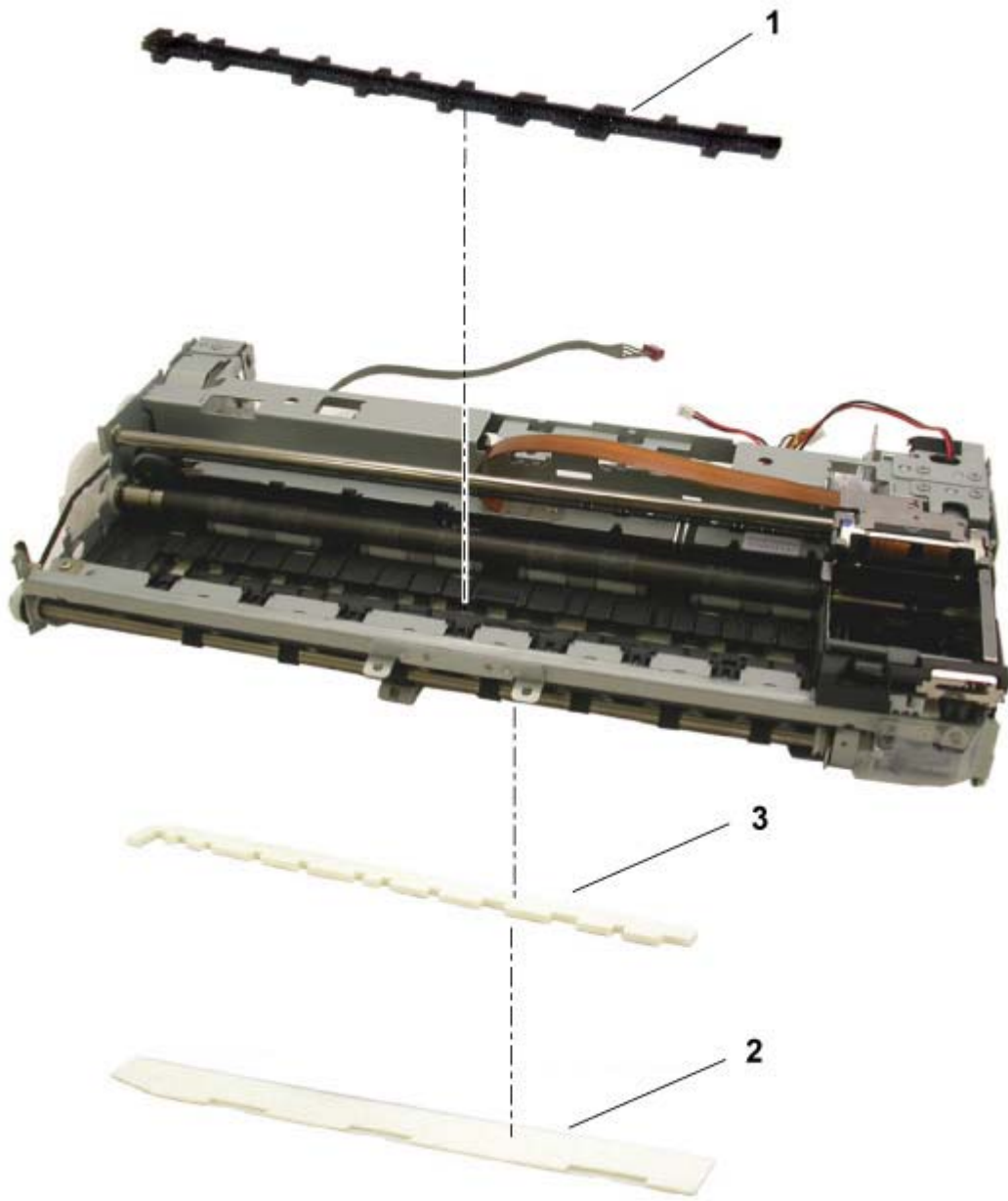

FIGURE & KEY No.		PART NUMBER	RANK	QTY	DESCRIPTION	REMARKS
8 -	1	QC1-5831-000		1	ABSORBER, INK	
	2	QC1-1212-000		1	ABSORBER, INK	WITH FILM
	3	QC1-1211-000		1	ABSORBER, INK	

FIGURE 9 CARRIAGE UNIT & PURGE UNIT

NOTE:

1. At the first step, lower the head cap.
2. Raise the head cap, and then remove Key No. 22.
3. For Key No. 10 and 20, use a new one upon the re-installation.

注:

1. 最初にヘッドキャップを下げてください。
2. Key No. 22を取り外す前にヘッドキャップを上げてください。
3. Key No. 10と20は再使用不可です。組み込みの際は新品を使用してください。

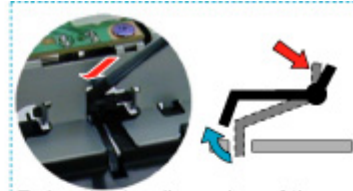

Raise the leading edge of the sensor arm upon the disinstallation of Key No. 14 and re-installation of Key No. 17. Key No. 14の取り外しと、Key No. 17の組み込みの際は、センサーアームの先端を上げてください。

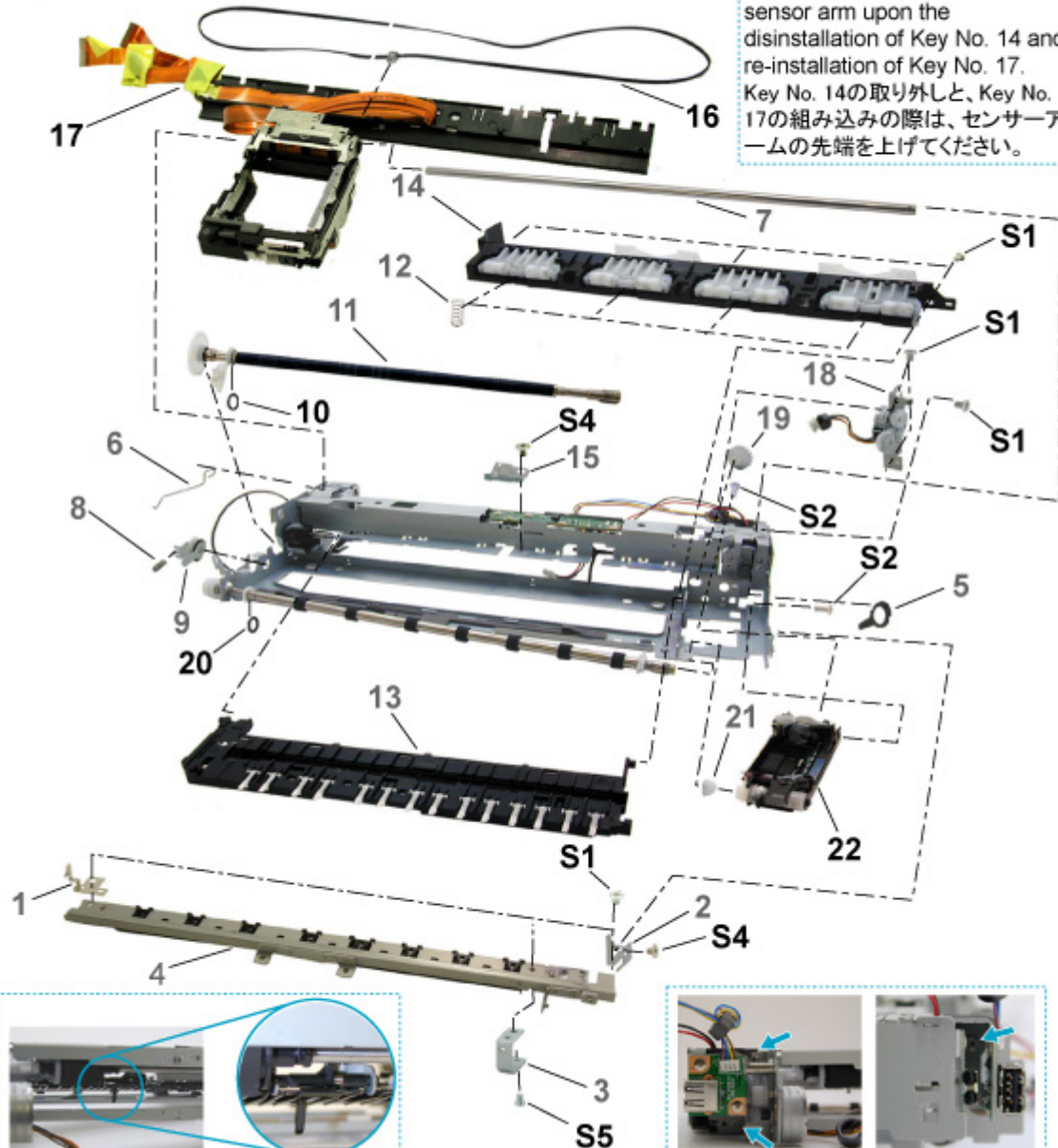

Confirm the sensor arm and spring do not come off.
センサーアームとバネが正常に組み込まれていることを確認してください。

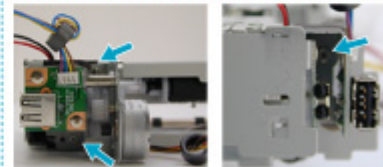

Remove these screws, and then remove Key No. 18.
3本のビスを取り外し、Key No. 18を取り外してください。

FIGURE & KEY No.		PART NUMBER	RANK	QTY	DESCRIPTION	REMARKS
9 -	10	QC1-5815-000		1	SLIT RING, PAPER FEED ROLLER	
	16	QC1-1205-000		1	BELT, CARRIAGE	
	17	QM2-2016-000		1	CARRIAGE UNIT	
	20	QC1-5816-000		1	SLIT RING, EJECT ROLLER	
	22	QM2-2024-000		1	PURGE UNIT	

FIGURE 10 MAIN BOARD PARTS & COIN BATTERY UNIT

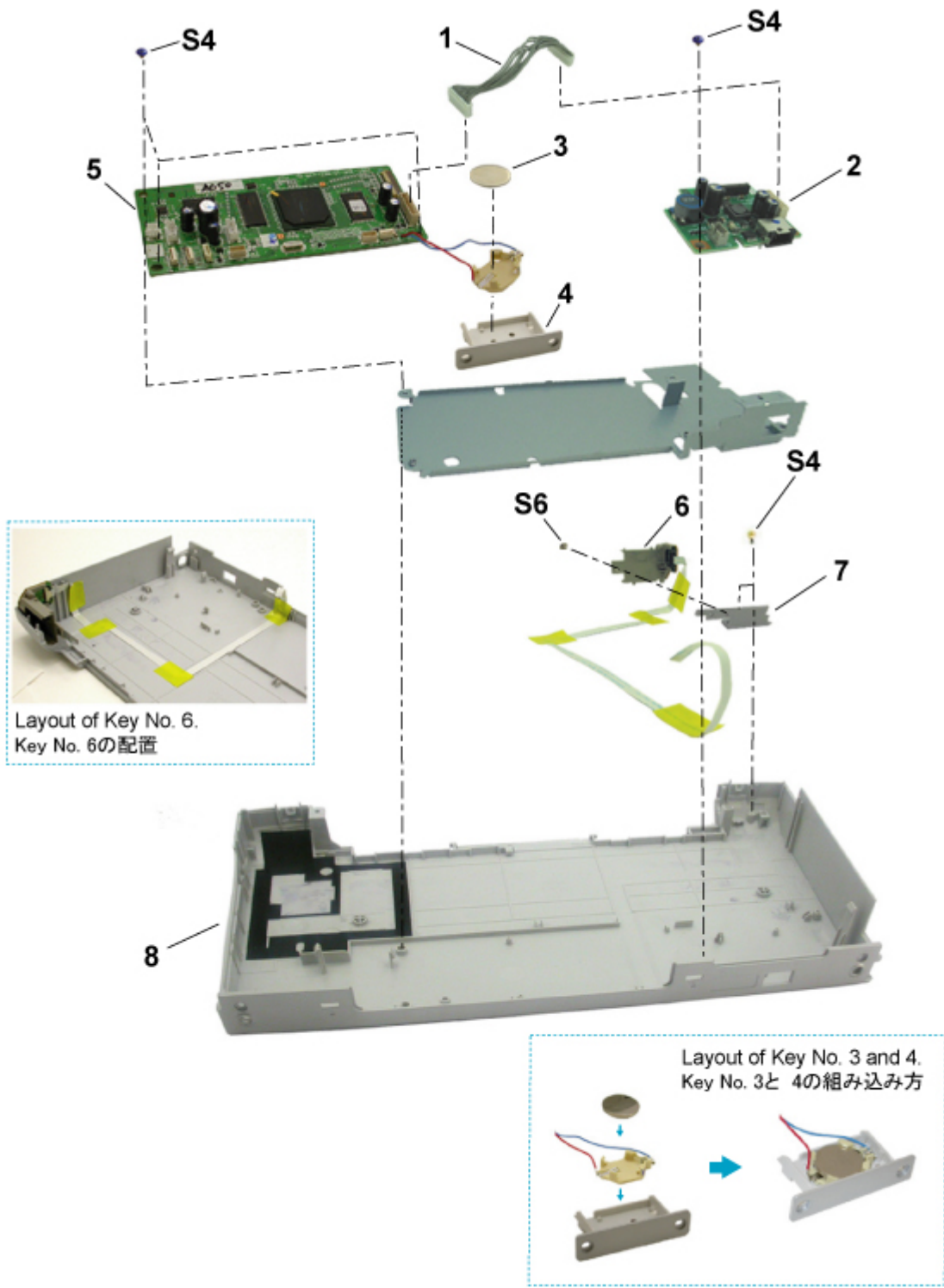

FIGURE & KEY No.		PART NUMBER	RANK	QTY	DESCRIPTION	REMARKS
10 -	1	QM2-1263-000		1	DCDC HARNESS ASS'Y	
	2	QM2-2079-000		1	DCDC BOARD ASS'Y	
	3	NPN		1	COIN BATTERY	
	4	QL2-0872-000		1	COIN BATTERY CASE ASS'Y	
	5	QM2-2068-000		1	LOGIC BOARD ASS'Y	
	6	QM2-2021-000		1	BLUETOOTH ASS'Y	
	7	NPN		1	PLATE, FRONT CRAMP L	
	8	QL2-0865-000		1	BASE ASS'Y	

FIGURE 11 OPTION & CONSUMABLES



FIGURE & KEY No.		PART NUMBER	RANK	QTY	DESCRIPTION	REMARKS
11 -	1	NPN		1	BLACK INK TANK BCI-15BLACK	CONSUMABLES
	2	NPN		1	COLOR INK TANK BCI-15COLOR	CONSUMABLES
	3	QY5-0137-000		1	BLUETOOTH MODULE KIT	JP
		QY5-0138-000		1	BLUETOOTH MODULE KIT	US, CA
		QY5-0139-000		1	BLUETOOTH MODULE KIT	ASA
		QY5-0140-000		1	BLUETOOTH MODULE KIT	CN
		QY5-0141-000		1	BLUETOOTH MODULE KIT	EUR
		QY5-0142-000		1	BLUETOOTH MODULE KIT	TW
	4	QM2-2028-000		1	CHARGE, BATTERY	(W/O BATTERY)
	5	QK1-0006-000		1	BATTERY	OVERSEAS
		QK1-0057-000		1	BATTERY	JP
	6	QK1-1600-000		1	CRADLE	
	7	QK1-0604-000		1	AUTOMOBIL POWER UNIT	
	8	QK1-1225-000		1	AC ADAPTER: 100V-240V 50/60HZ	REGIONS EXCEPT RUSSIA, AUSTRALIA, NEW ZEALAND, TAIWAN SINGAPORE, SAUDI ARABIA AND CHINA
	9	QK1-0774-000		1	CORD, POWER	220V-240V(KR)
		QK1-0777-000		1	CORD, POWER	220V-240V(AUST)
		QK1-1348-000		1	CORD, POWER	100V
		WT3-5173-000		1	CORD, POWER	220V-240V
		WT3-5174-000		1	CORD, POWER	220V-240V(UK)
		WT3-5176-000		1	CORD, POWER	120V
		WT3-5177-000		1	CORD, POWER	220V-240V(CN)

D. SCREW & WASHER LIST

[Contents](#)

FIGURE & KEY No.		PART NUMBER	RANK	QTY	DESCRIPTION	REMARKS
S -	1	XA1-7260-305			SCREW, MACH. PAN HEAD, M2.6X3	
	2	XA4-9260-605			SCREW, M2.6X6	
	3	XA9-0742-000			SMALL SCREW, 5.5X2.6MM	
	4	XA9-1425-000			SCREW, PAN HEAD, M2X2.2	
	5	XA1-7200-305			SCREW, M2.0X3	
	6	XA4-8200-455			SCREW, M2.0X4.5	

This page intentionally left blank

FIGURE 12 TOOL

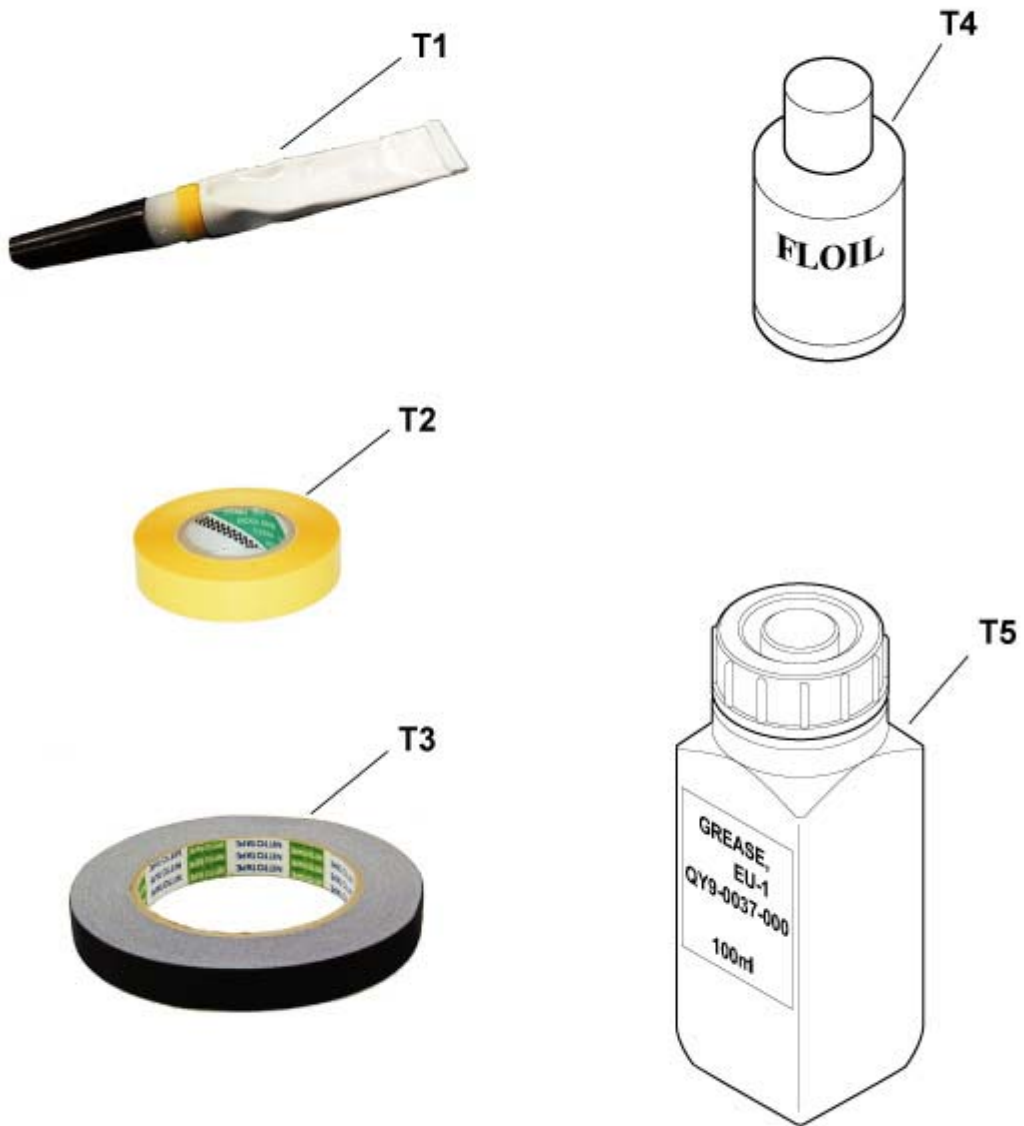

FIGURE & KEY No.		PART NUMBER	RANK	QTY	DESCRIPTION	REMARKS
T -	1	QY9-0059-000		1	GREASE, MOLYKOTE 7508	
	2	QY9-0060-000		1	TAPE, YELLOW	
	3	QY9-0061-000		1	TAPE, BLACK	
	4	QY9-0057-000		1	LUBE, FLOIL KG107A, OIL	
	5	QY9-0037-000		1	GREASE EU-1	

F. NUMERICAL INDEX

PART NUMBER	FIGURE & KEY No.		DESCRIPTION
QC1-1205-000	9 -	16	BELT, CARRIAGE
QC1-1211-000	8 -	3	ABSORBER, INK
QC1-1212-000	8 -	2	ABSORBER, INK
QC1-1310-000	6 -	3	HOLDER, FLEXIBLE CABLE
QC1-3998-000	6 -	4	FILM, TIMING SLIT STRIP
QC1-5789-000	6 -	6	SHEET, EDGE COVER
QC1-5793-000	3 -	2	COVER, PRINT HEAD
QC1-5801-000	2 -	4	WINDOW, SIDE
QC1-5802-000	2 -	5	COVER, SIDE R
QC1-5805-000	2 -	1	EMBLEM, PIXMA
QC1-5812-000	2 -	3	COVER, SIDE L
QC1-5815-000	9 -	10	SLIT RING, PAPER FEED ROLLER
QC1-5816-000	9 -	20	SLIT RING, EJECT ROLLER
QC1-5831-000	8 -	1	ABSORBER, INK
QC1-5834-000	2 -	1	EMBLEM, PIXUS
QK1-0006-000	11 -	5	BATTERY
QK1-0057-000	11 -	5	BATTERY
QK1-0604-000	11 -	7	AUTOMOBIL POWER UNIT
QK1-0774-000	11 -	9	CORD, POWER
QK1-0777-000	11 -	9	CORD, POWER
QK1-1225-000	11 -	8	AC ADAPTER: 100V-240V 50/60HZ
QK1-1236-000	6 -	2	CABLE, PANEL FLEXIBLE
QK1-1237-000	6 -	1	CABLE, IRDA FLEXIBLE
QK1-1348-000	11 -	9	CORD, POWER
QK1-1600-000	11 -	6	CRADLE
QL2-0194-000	6 -	5	DRAIN PACK ASS'Y
QL2-0865-000	10 -	8	BASE ASS'Y
QL2-0869-000	2 -	2	TRAY, FEED PIXUS
QL2-0870-000	2 -	6	OUTPUT SLOT COVER UNIT
QL2-0872-000	10 -	4	COIN BATTERY CASE ASS'Y
QL2-0873-000	2 -	2	TRAY, FEED PIXMA
QM2-1263-000	10 -	1	DCDC HARNESS ASS'Y
QM2-2015-000	3 -	1	MAIN CASE UNIT
QM2-2016-000	9 -	17	CARRIAGE UNIT
QM2-2017-000	4 -	2	PRESSING PLATE UNIT
QM2-2020-000	6 -	7	PRINT UNIT
QM2-2021-000	10 -	6	BLUETOOTH ASS'Y
QM2-2022-000	7 -	3	USB BOARD ASS'Y
QM2-2024-000	9 -	22	PURGE UNIT
QM2-2028-000	11 -	4	CHARGE, BATTERY
QM2-2068-000	10 -	5	LOGIC BOARD ASS'Y
QM2-2069-000	7 -	1	PANEL BOARD ASS'Y
QM2-2070-000	7 -	4	DOOR SENSOR BOARD ASS'Y
QM2-2074-000	7 -	2	DCD BOARD ASS'Y

PART NUMBER	FIGURE & KEY No.		DESCRIPTION
QM2-2079-000	10 -	2	DCDC BOARD ASS'Y
QY5-0137-000	11 -	3	BLUETOOTH MODULE KIT
QY5-0138-000	11 -	3	BLUETOOTH MODULE KIT
QY5-0139-000	11 -	3	BLUETOOTH MODULE KIT
QY5-0140-000	11 -	3	BLUETOOTH MODULE KIT
QY5-0141-000	11 -	3	BLUETOOTH MODULE KIT
QY5-0142-000	11 -	3	BLUETOOTH MODULE KIT
QY6-0052-000	1 -	1	PRINT HEAD
QY9-0037-000	T -	5	GREASE EU-1
QY9-0057-000	T -	4	LUBE, FLOIL KG107A, OIL
QY9-0059-000	T -	1	GREASE, MOLYKOTE 7508
QY9-0060-000	T -	2	TAPE, YELLOW
QY9-0061-000	T -	3	TAPE, BLACK
WE8-6045-000	5 -	2	CORE, FERRITE RING
WE8-6242-000	5 -	1	CORE, FERRITE
WT3-5173-000	11 -	9	CORD, POWER
WT3-5174-000	11 -	9	CORD, POWER
WT3-5176-000	11 -	9	CORD, POWER
WT3-5177-000	11 -	9	CORD, POWER
XA1-7200-305	S -	5	SCREW, M2.0X3
XA1-7260-305	S -	1	SCREW, MACH. PAN HEAD, M2.6X3
XA4-8200-455	S -	6	SCREW, M2.0X4.5
XA4-9260-605	S -	2	SCREW, M2.6X6
XA9-0742-000	S -	3	SMALL SCREW, 5.5X2.6MM
XA9-1425-000	S -	4	SCREW, PAN HEAD, M2X2.2